

# AM1149-D – Amplifier

## 6 to 26.5 GHz Slope Correcting Gain Block

**AM1149-D is a wideband, cascadable amplifier servicing the 6 to 26.5 GHz frequency range.** The device exhibits 2 dB of positive gain slope across the frequency range. The increasing gain across frequency makes the AM1149-D an ideal solution to equalize gain/insertion loss across an RF system. Available as bare die in a 1.34mm x 0.91mm footprint with internal 50Ω matching and DC blocking capacitors, the AM1149-D is a small form-factor solution that can enable low SWaP applications.

### FEATURES

- 2 dB Gain Slope
- 12.5 dB Gain at 6 GHz
- 14.5 dB Gain at 26.5 GHz
- 2.6 dB Noise Figure
- +25 dBm OIP3
- +12 dBm P1dB
- +3.3V Operation
- -40C to +85C Operation

### CHARACTERISTIC PERFORMANCE

#### FUNCTIONAL DIAGRAM

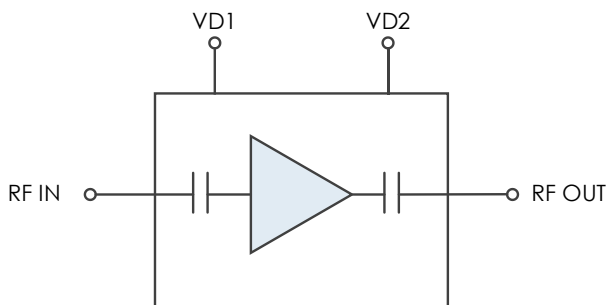

**Gain and Return Loss at +25C**

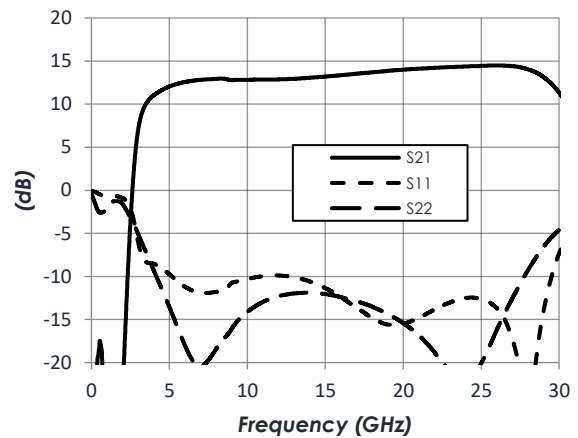

**Noise Figure at +25C**

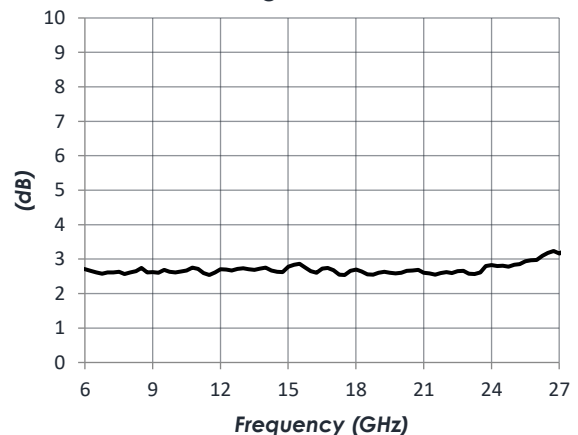

CONTENTS

FEATURES ..... 1

FUNCTIONAL DIAGRAM ..... 1

CHARACTERISTIC PERFORMANCE ..... 1

REVISION HISTORY..... 2

PIN LAYOUT AND DEFINITIONS ..... 3

SPECIFICATIONS..... 4

TYPICAL PERFORMANCE ..... 5

TYPICAL APPLICATION..... 7

RECOMMENDED COMPONENT LIST (OR EQUIVALENT) ..... 7

DIE DIMENSIONS ..... 8

PART ORDERING DETAILS ..... 8

RECOMMENDED WIRE BONDS..... 9

RELATED PARTS..... 9

COMPONENT COMPLIANCE INFORMATION ..... 10

REVISION HISTORY

Date	Revision	Notes
June 19, 2024	1	Initial Release

PIN LAYOUT AND DEFINITIONS

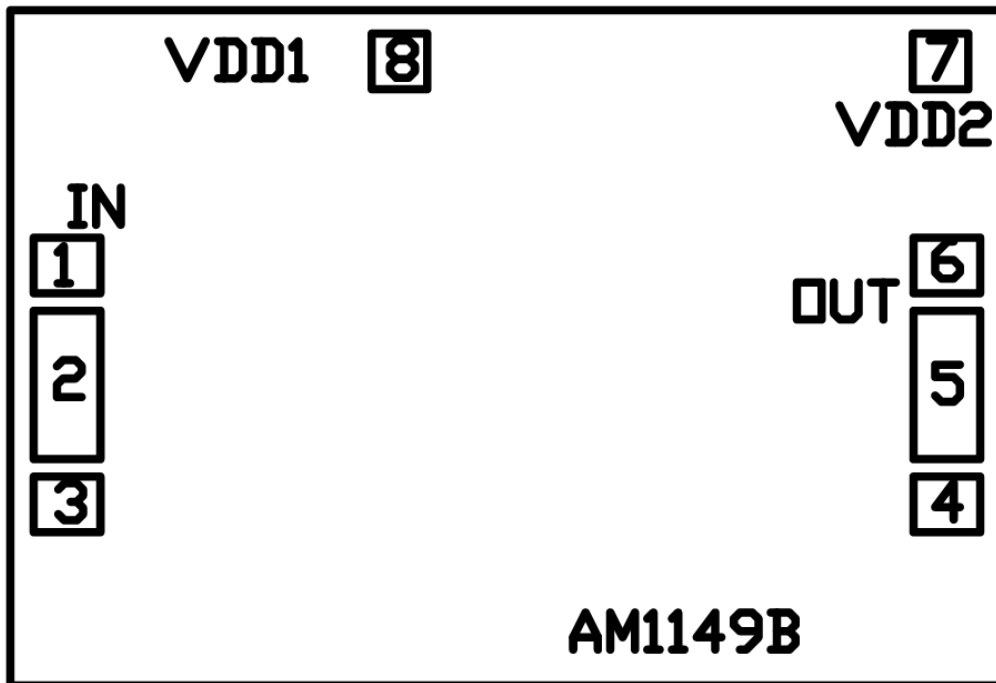

Pin	Name	Function
1	GND	Ground - Common
2	RF In	RF Input - 50 Ohms - AC Coupled
3	GND	Ground - Common
4	GND	Ground - Common
5	RF Out	RF Output - 50 Ohms - AC Coupled
6	GND	Ground - Common
7	VD2	DC Power Input 2
8	VD1	DC Power Input 1

SPECIFICATIONS

Absolute Maximum Ratings

	Minimum	Maximum
Supply Voltage	-0.3 V	+3.6 V
RF Input Power		15 dBm
Storage Temperature Range	-55 C	+150 C

**Note:** Any device operation beyond the Absolute Maximum Ratings may result in permanent damage to the device. The values listed in this table are extremes and do not imply functional operation of the device at these or any other conditions beyond what is listed under Recommended Operating Conditions. Any part subjected to conditions outside of what is recommended for an extended amount of time may suffer from reliability concerns.

Handling Information

	Minimum	Maximum
ESD Sensitivity – Human Body Model (HBM)	Class 0A	



Mercury products are electrostatic sensitive. Follow safe handling practices to avoid damage.

Recommended Operating Conditions

	Minimum	Typical	Maximum
Supply Voltage		+3.3 V	
Operating Case Temperature	-40 C		+85 C

Thermal Information

Thermal Resistance (channel to backside ground)	208 C/W
Nominal Junction Temperature at +85C Ambient	153 C
Channel Temperature to Maintain 1 Million Hour MTTF	175 C

DC Electrical Characteristics

(T = 25 °C unless otherwise specified)

Param	Testing Conditions	Min	Typical	Max
DC Supply Voltage			+3.3 V	
DC Supply Current	VDD = +3.3 V, Total		97 mA	
	VD1 Current	47 mA		53 mA
	VD2 Current	44 mA		51 mA
Power Dissipated	VDD = +3.3 V		320 mW	

RF Performance

(T = 25 °C unless otherwise specified)

Param	Testing Conditions	Min	Typical	Max
Frequency Range		6 GHz		26.5 GHz
Insertion Loss	f = 6 GHz		12.5 dB	
	f = 16 GHz		13.4 dB	
	f = 26.5 GHz		14.5 dB	
Return Loss	f = 6 GHz		-11 dB	
	f = 16 GHz		-12 dB	
	f = 26.5 GHz		-13 dB	
Output IP3	f = 16 GHz		24.5 dBm	
Output P1dB	f = 16 GHz		12 dBm	
Noise Figure	f = 16 GHz		2.6 dB	

Notes:

1. IP3 measured with -10dBm input power tones at 10MHz spacing.

TYPICAL PERFORMANCE

(VDD = +3.3V, T = 25 °C unless otherwise specified)

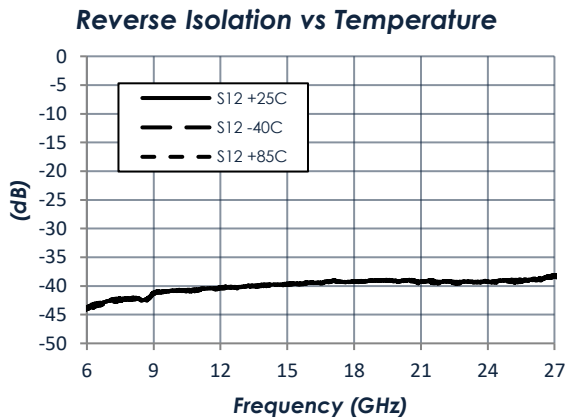
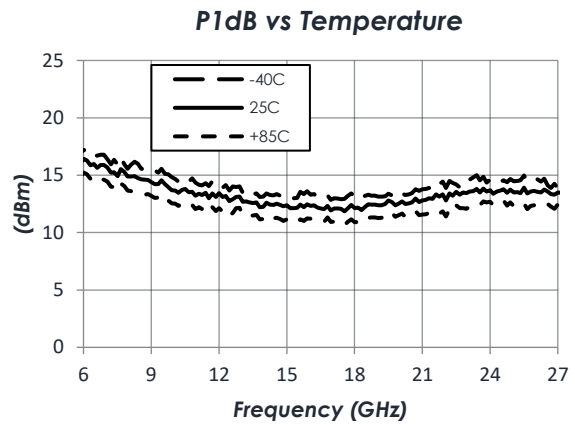
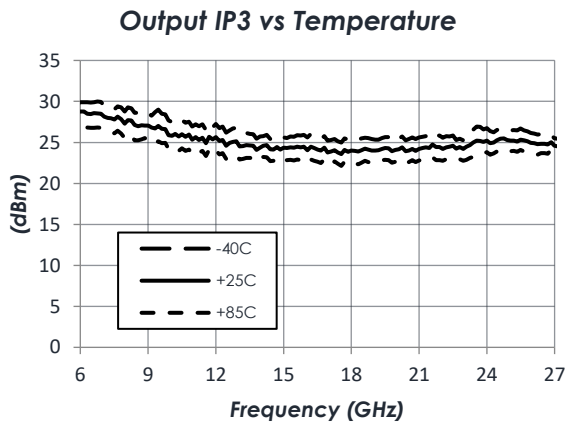
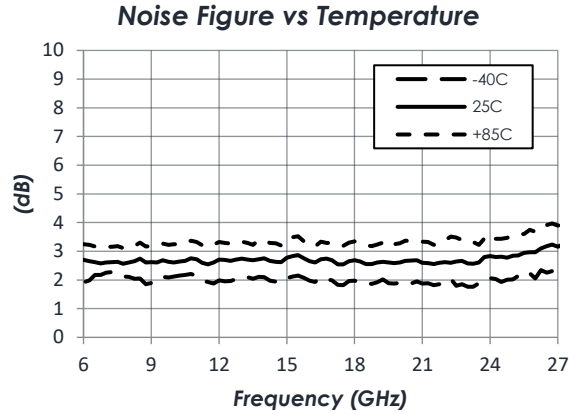
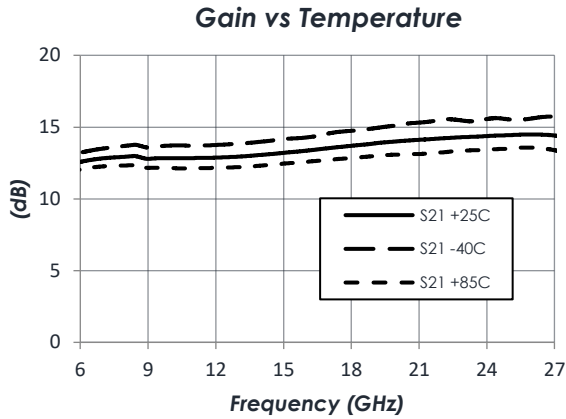

TYPICAL PERFORMANCE (continued)

(VDD = +3.3V, T = 25 °C unless otherwise specified)

Power Saturation

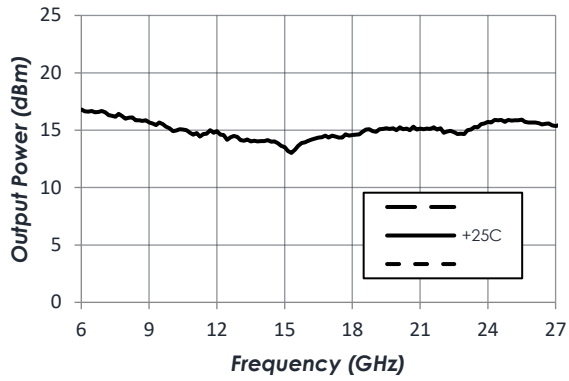

Pin vs. Pout at +25C

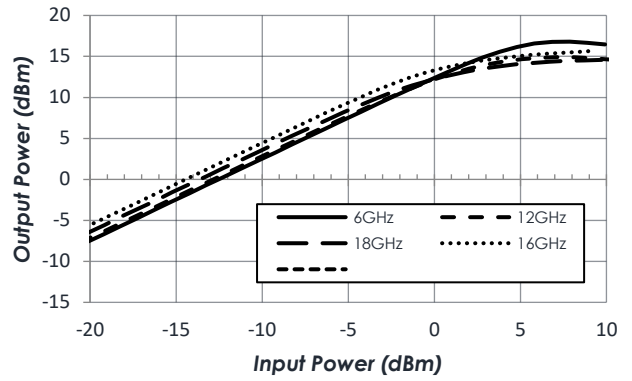

TYPICAL APPLICATION

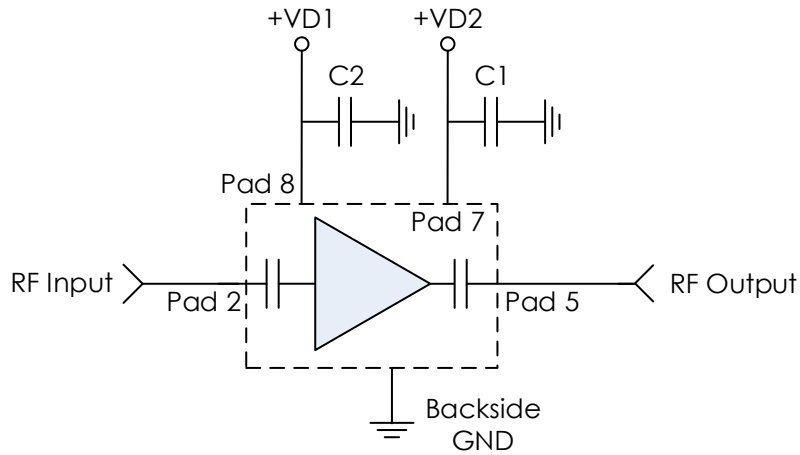

RECOMMENDED COMPONENT LIST (OR EQUIVALENT)

Part	Value	Part Number	Manufacturer
C1, C2	100 pF	SKT01A101Z10A6	Tecdia

Notes:

1. AM1149-D is AC coupled. No external DC blocking capacitors are required.

DIE DIMENSIONS

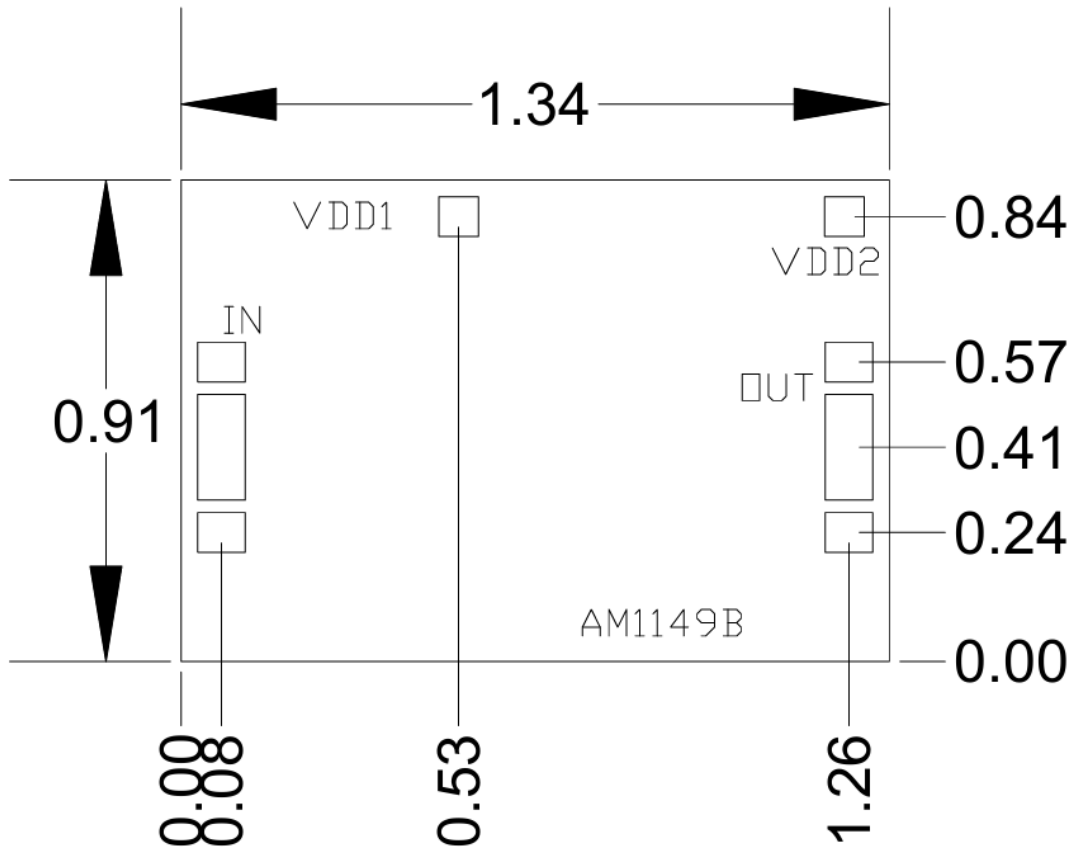

PART ORDERING DETAILS

Description	Part Number
1.34mm x 0.91mm Bare Die	AM1149-D
3mm 12 Lead QFN	AM1149
AM1149 3mm QFN Evaluation Board	AM1149 Eval



RECOMMENDED WIRE BONDS

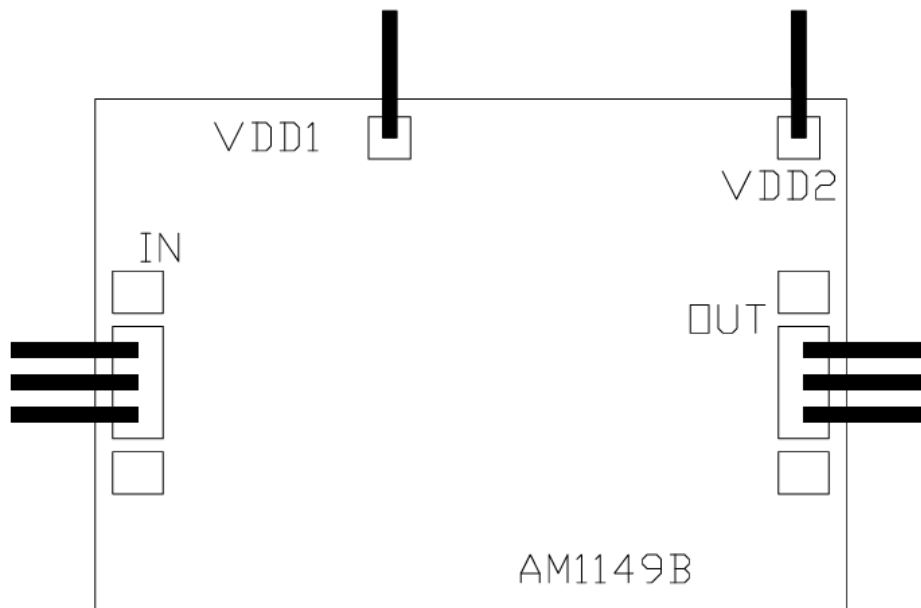

Notes:

1. RF pads should have three bonds.
2. All bonds should be minimum length, minimum loop height, and evenly spaced for optimum performance.
3. Bonds should be 1 mil, gold.

RELATED PARTS

Part Number		Manufacturer
AM1101	2 GHz to 26.5 GHz	Bypassable Amplifier
AM1134	6 GHz to 26.5 GHz	Low Noise Amplifier
AM1147	6 GHz to 26.5 GHz	Slope Correcting Amplifier
AM1148	6 GHz to 26.5 GHz	Slope Correcting Amplifier

COMPONENT COMPLIANCE INFORMATION

**RoHS:** Mercury Systems, Inc. hereby certifies that all products comply with the EC Directive 2011/65/EC on the Restriction of Hazardous Substances, commonly known as EU-RoHS 6 and 10. All products supplied by Mercury shall be compliant with the European Directive 2011/65/EC based on the following substance list.

Substance List	Allowable Maximum Concentration
Lead (Pb)	<1000 PPM (0.1% by weight)
Mercury (Hg)	<1000 PPM (0.1% by weight)
Cadmium (Cd)	<75 PPM (0.0075% by weight)
Hexavalent Chromium (CrVI)	<1000 PPM (0.1% by weight)
Polybrominated Biphenyls (PBB)	<1000 PPM (0.1% by weight)
Polybrominated Diphenyl ethers (PBDE)	<1000 PPM (0.1% by weight)
Decabromodiphenyl Deca BDE	<1000 PPM (0.1% by weight)
Bis (2-ethylhexyl) Phthalate (DEHP)	<1000 PPM (0.1% by weight)
Butyl Benzyl Phthalate (BBP)	<1000 PPM (0.1% by weight)
Dibutyl Phthalate (DBP)	<1000 PPM (0.1% by weight)
Diisobutyl Phthalate (DIBP)	<1000 PPM (0.1% by weight)

**REACH:** Mercury Systems, Inc. neither uses nor intentionally adds any of the substances considered to be a Substance of Very High Concern (SVHC) as defined by the EU Regulation (EC) No. 1907-2006 on Registration, Evaluation, Authorization, and Restriction of Chemicals (REACH).

**Conflict Materials:** Mercury does not knowingly use materials that are sourced from the Democratic Republic of Congo (DRC) or any other known conflict regions. Mercury’s supply chain is comprised of sources that are both environmentally and socially responsible. We periodically review this requirement with our vendors to ensure continued compliance.

**Mercury takes its responsibility as a global partner seriously and will use due diligence within our supply chain to ensure all standards are met to the best of our knowledge.**



**Corporate Headquarters**

50 Minuteman Road  
 Andover, MA 01810 USA  
 +1 978.967.1401 tel  
 +1 866.627.6951 tel  
 +1 978.256.3599 fax

**International Headquarters**

**Mercury International**  
 Avenue Eugène-Lance, 38  
 PO Box 584  
 CH-1212 Grand-Lancy 1  
 Geneva, Switzerland  
 +41 22 884 5100 tel

**Learn more**

**Visit:** [mrcy.com](http://mrcy.com)

For pricing details, contact: [MMICsales@mrcy.com](mailto:MMICsales@mrcy.com)

For technical details, contact: [MMICsupport@mrcy.com](mailto:MMICsupport@mrcy.com)



The Mercury Systems logo is a registered trademark of Mercury Systems, Inc. Other marks used herein may be trademarks or registered trademarks of their respective holders. Mercury products identified in this document conform with the specifications and standards described herein. Conformance to any such standards is based solely on Mercury’s internal processes and methods. The information contained in this document is subject to change at any time without notice.

